

Discrimination between internal faults and inrush currents in power transformers using the wavelet transform

Gaddala Jaya Raju

Associate Professor, Tirumala Engineering College
jayaraju2006@gmail.com

Abstract

The power transformer protection plays vital role in power systems. Any power transformer protective scheme has to take into account the effect of magnetising inrush currents. Since during the energization of the transformer, sometimes results in 10 times full load currents and can cause mal operation of the relays. The ratio of the second harmonic to the fundamental harmonic of the inrush current is greater than that of the fault current. To avoid this we go for conventional protection scheme by sensing the large second harmonic. The second harmonic in these situations might be greater than the second harmonic in inrush currents. The differential power method has the disadvantage that the need to use voltage transforms and increased protection algorithm calculation cost. Neural networks have the disadvantage that it requires a large of learning patterns produced by simulation of various cases. This paper describes the discrimination between internal faults and inrush currents in power transformers using the wavelet transform based feature extraction technique. It is shown that the features extracted by the wavelet transform have a more distinctive property than those extracted by the fast Fourier transform due to the good time and frequency localization characteristics of the wavelet transform. The performance of this is demonstrated by simulation of different faults and switching conditions on a power transformer using MATLAB software.

Introduction

The power transformer protection is of critical importance in power systems. Any power transformer protective scheme has to take into account the effect of magnetising inrush currents. This is because the magnetising inrush current, which occurs during the energization of the transformer, sometimes results in 10 times full load currents and therefore can cause mal operation of the relays. Accurately discriminating magnetising inrush currents from internal faults has long been recognized as a very challenging problem to power transformer protection engineers.

Wavelet transform (WT) has been introduced rather recently in mathematics, even though the essential ideas that lead to this development have been around for a longer period of time. It is a linear transformation much like the Fourier transform, however it allows time localization of differences frequency components of a given signal: windowed Fourier transform (STFT) also partially achieves the same goal, but the fixed width windowing function is a limitation. In the case of the wavelet transform, the analyzing functions called wavelets, will adjust the time width to the frequency in such a way that high frequency wavelets will be very narrow and lower frequency ones will be broader. There are two main approaches to present wavelet theory: the integral transform approach (continuous time) and the multiresolution analysis (MRA)/filter bank approach (discrete time).

Several works have been developed in many areas with the aim of this tool, specially, in the last ten years have been met the potential benefits of applying WT to power systems due to, among other, the interest in analyzing and processing the

voltage-current signals in order to nuke a real time identification of transients in a fast and accurate way.

In this paper, the wavelet transform technique is first applied to decompose the differential current signals through the CTs secondary side into a series of wavelet components, each of which is a time-domain signal that covers a specific frequency band. The extensive simulation results presented show that the proposed technique needs very simple input signals (differential currents), but can accurately discriminate between an internal fault and inrush current in different power transformer systems.

Transformer protection

Before the transient inrush current can be analyzed, the previous de-energisation must be looked at. During this process the residual flux will attend a certain value that is important for the next energisation of the power transformer.

Residual flux

Looking at a single-phase transformer and neglecting leakage and other magnetic air fluxes as well as the coil resistance, the magnetic core flux Φ_{core} is related to the coil voltage u_{coil} by Equation (1).

$$u_{coil}(t) = N_{coil} \frac{d\Phi_{core}(t)}{dt} \quad (1)$$

When de-energizing the transformer out of no-load steady state, the current will be Interrupted at time t_{open} and the residual flux Φ_{Res} is calculated using Equation (1):

$$\Phi_{Res} = \frac{1}{N_{coil}} \int u_{coil}(t) dt$$

With

$$u_{coil}(t) = U_0 \sin(\omega_0 t)$$

and assuming steady-state, Equation (2) becomes

$$\Phi_{Res} = -\Phi_0 \cos(\omega_0 t_{open}). \quad (2)$$

Because the magnetising current of transformers is often smaller than the chopping current of the circuit breaker, the current will be interrupted prior to its natural zero crossing and the opening time T_{open} of Equation (2) can take any value. As a consequence of this, the residual flux can reach any value between -1 p.u. and 1 p.u. Because no magnetizing curve is able to exceed the maximum magnetizing characteristic given by the properties of the core material, the residual flux margin will shrink to the range between the two points of the maxima residual flux $\pm\Phi_{Res, max}$ (Figure 1). In real substations the maximal accessible residual flux is further reduced to a value of approximately 0.9 p.u. due to transients during de-energisation (micro hysteresis loop) as can be seen in Figure 1.

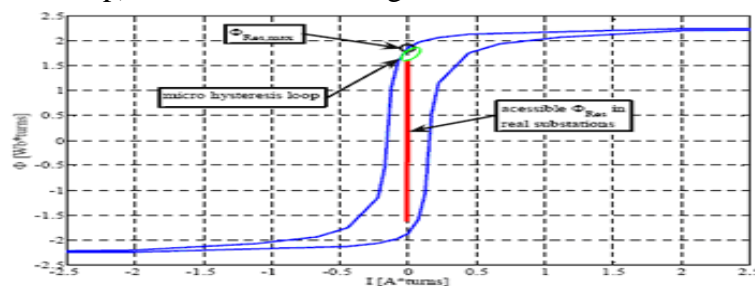

Fig.1. Maximum magnetizing characteristics and range of accessible residual flux

Formation of inrush current

If a transformer is energized at a random instant, it is possible that no transient inrush current will occur; but mostly transient inrush currents will arise. This happens because transient inrush currents depend not only on the instant of energisation, but also on the residual flux of the previous de-energisation.

Using equations (1) and (3), the magnetic flux during the first period of energisation can be calculated analytically neglecting damping effects (core losses, winding resistance):

$$\begin{aligned}\Phi_{core}(t) &= \frac{1}{N_{coil}} \int_{t_{close}}^t u_{coil}(t) dt + \Phi_{Res} \\ &= -\Phi_0 \cos(\omega_0 t) + \underbrace{\Phi_0 \cos(\omega_0 t_{close})}_{\Phi_{offset}} + \Phi_{Res}\end{aligned}\quad (3)$$

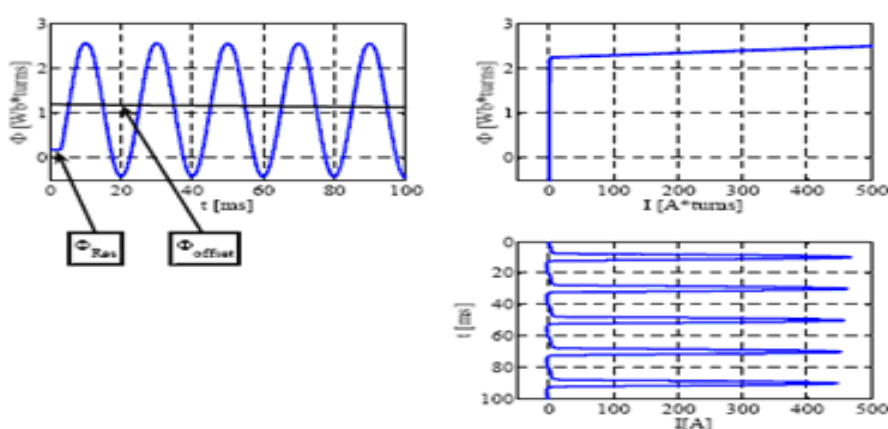

Fig 2. Magnetic flux Φ and inrush current I ($\Phi_{Res} = 0.1$ p.u & $T_{close} = 3$ ms)

Controlled switching taking into account the residual flux – Single phase strategy

As mentioned above, controlled switching taking into account the residual flux can be used for many different transformer configurations. There is not a single “multi purpose” strategy; there exist many strategies for different transformer configurations, measurement systems and circuit breaker configurations. Except for the simultaneous closing strategy, the method for the first phase to be energized is always the same and will be shortly discussed in this section.

No transient inrush current will appear if the optimal moment of energisation is met. Assuming steady state and a virtually closed circuit breaker, the virtual magnetic core flux corresponds to the integral of the source voltage virtually applied to the transformer. This virtual magnetic flux is called prospective flux (Φ_{prosp}). At the optimal instant of energisation t_{opt} , the prospective flux has to be equal to the residual flux (see Figure 3) and Equation (5) can be rewritten as:

$$\Phi_{offset}(t_{opt}) = \underbrace{\Phi_0 \cos(\omega_0 t)}_{\Phi_{prosp}} + \Phi_{Res} = 0\quad (4)$$

The optimal instant of energisation without considering pre-strike of real circuit breakers can be calculated as follows:

$$\text{if } \Phi_{Res} < 0 : t_{opt} = -\frac{1}{\omega_0} \arccos\left(\frac{\Phi_{Res}}{\Phi_0}\right)$$

$$\text{else} : t_{opt} = \frac{1}{\omega_0} \left[\arccos\left(\frac{\Phi_{Res}}{\Phi_0}\right) + 1 \right]$$

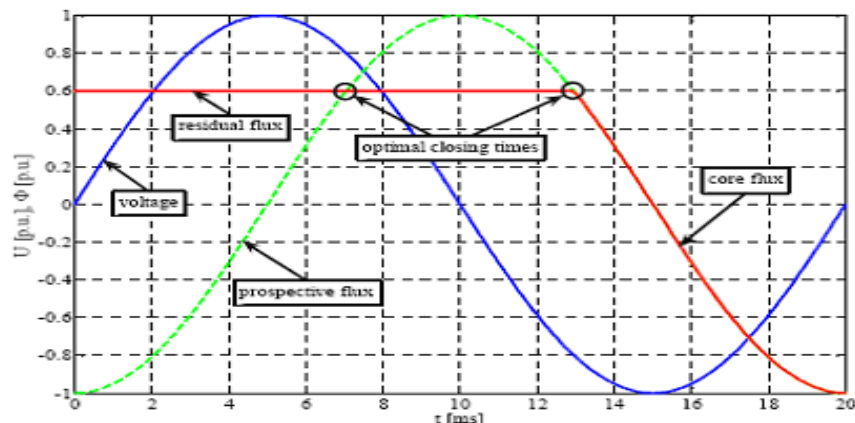

Fig 3 Optimal closing times for single phase strategy

General Inrush Current Equation: [9]

$$\left[\frac{\sqrt{2}U}{z_i} \left(\sin(\omega t - \varphi) - e^{-\frac{(t-t_0)}{\tau}} \cdot \sin \alpha \right) \cdot K_w \cdot K_s \right] \quad (5)$$

Wavelets

A **wavelet** is a mathematical function used to divide a given function or [continuous-time signal](#) into different frequency components and study each component with a resolution that matches its scale. A **wavelet transform** is the representation of a function by wavelets. The wavelets are [scaled](#) and [translated](#) copies (known as "daughter wavelets") of a finite-length or fast-decaying oscillating waveform (known as the "mother wavelet"). Wavelet transforms have advantages over traditional [Fourier transforms](#) for representing functions that have discontinuities and sharp peaks, and for accurately deconstructing and reconstructing finite, non-[periodic](#) and/or non-[stationary](#) signals.

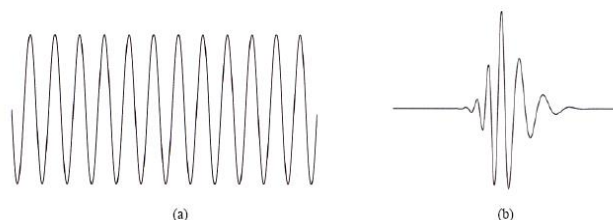

“A wavelet is a waveform of effectively limited duration that has an average value of zero” 4.1(a), 4.1(b)

Demonstration of a Wave and a Wavelet

The wavelet analysis is done similar to the STFT analysis. The signal to be analyzed is multiplied with a wavelet function just as it is multiplied with a window function in

STFT, and then the transform is computed for each segment generated. However, unlike STFT, in Wavelet Transform, the width of the wavelet function changes with each spectral component. The Wavelet Transform, at high frequencies, gives good time resolution and poor frequency resolution, while at low frequencies; the Wavelet Transform gives good frequency resolution and poor time resolution.

Wavelet analysis represents the next logical step: a windowing technique with variable-sized regions. Wavelet analysis allows the use of long time intervals where we want more precise low-frequency information, and shorter regions where we want high-frequency information.

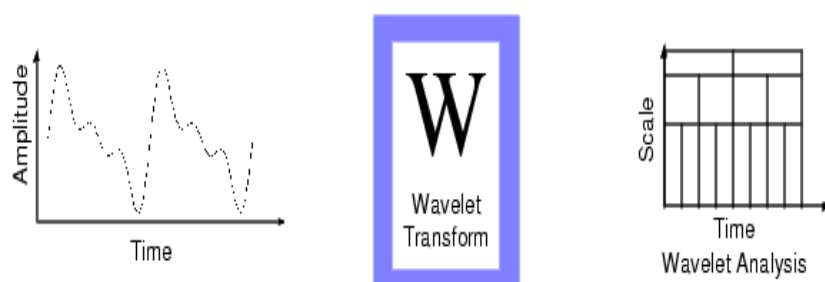

Fig.3 Wavelet Analysis of a given signal

Here's what this looks like in contrast with the time-based, frequency-based, and STFT views of a signal:

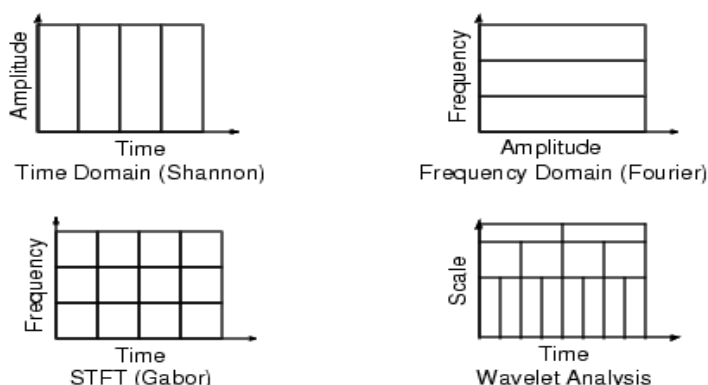

Fig.4 Comparison of Time-Domain, FT, STFT and WT

There is a wide range of applications for Wavelet Transforms. They are applied in different fields ranging from signal processing to biometrics, and the list is still growing. One of the prominent applications is in the FBI fingerprint compression standard. Wavelet Transforms are used to compress the fingerprint pictures for storage in their data bank. The previously chosen Discrete Cosine Transform (DCT) did not perform well at high compression ratios. It produced severe blocking effects which made it impossible to follow the ridge lines in the fingerprints after reconstruction. This did not happen with Wavelet Transform due to its property of retaining the details present in the data.

In DWT, the most prominent information in the signal appears in high amplitudes and the less prominent information appears in very low amplitudes. Data compression can be achieved by discarding these low amplitudes. The wavelet transforms enables high compression ratios with good quality of reconstruction. At present, the application of wavelets for image compression is one of the hottest areas of research. Recently, the Wavelet Transforms have been chosen for the JPEG 2000 compression standard.

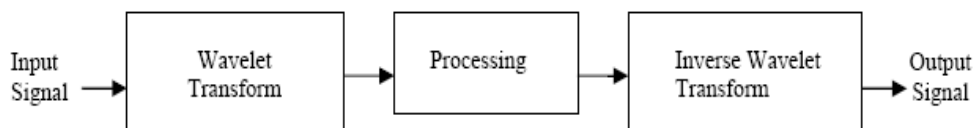

Fig.5 Signal Processing Application

Figure 3.23 shows the general steps followed in a signal processing application. Processing may involve compression, encoding, de-noising etc. The processed signal is either stored or transmitted. For most compression applications, processing involves quantization and entropy coding to yield a compressed image. During this process, all the wavelet coefficients that are below a chosen threshold are discarded. These discarded coefficients are replaced with zeros during reconstruction at the other end. To reconstruct the signal, the entropy coding is decoded, then quantized and then finally Inverse Wavelet Transformed.

Circuit descriptions

Single Line Diagram

The single line diagram of a three phase power transformer is as shown in fig given below. It consists of circuit breakers, current transformers, and a Y-Y connected three phase power transformer.

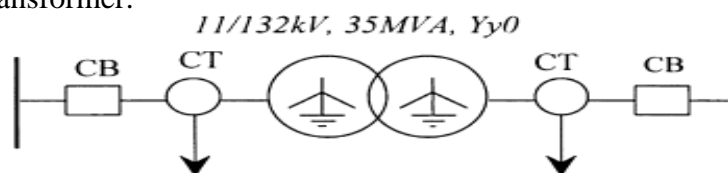

Fig 6 Single line diagram

Inrush Current Analysis

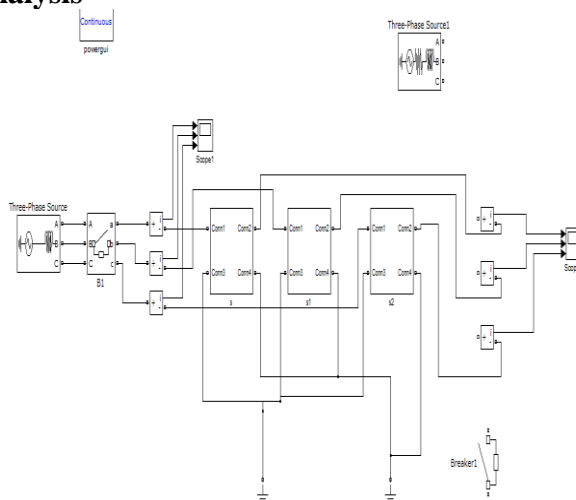

Fig 7. Simulation model for magnetising inrush current

Block Parameters:

Three phase voltage source

Phase –to- phase RMS voltage : 11 KV
 Frequency : 50Hz
 Phase angle of Phase A : 0°

Three phase transformer block parameters

Three phase power : 35 MVA

Nominal Power : 11.6 MVA
Frequency : 50 Hz

Primary winding details

Connection : Y - Y
Phase-to-phase RMS voltage : 11 KV
Winding Nominal Voltage : 6.35 KV
Resistance (in p.u) (R1) : 0.000015
Inductance (in p.u) (L1) : 0.0006

Secondary winding details

Connection : Y - Y
Phase-to-phase RMS voltage : 132 KV
Winding Nominal Voltage : 76.21 KV
Resistance (in p.u) (R2) : 0.000015
Inductance (in p.u) (L2) : 0.0006
Magnetizing resistance (Rm) (p.u) : 500

With the saturable core saturation characteristics (in p.u) are

i1	phi 1	i2	phi 2	i3	phi 3	i4	phi 4
0	0	0.025	0.177	0.0530	1.2045	13.8	1.4539

Initial fluxes: (phi0A phi0B phi0C)
0 0 0

3-Φ Circuit Breaker parameters

Breaker resistance (Ron) : 0.001 Ω
Initial state ('0' open, '1' close) : 0
Snubber resistance (Rs) : 1 MΩ
Snubber Capacitance (Cs) : inf
Switching timings : user defined
Sample time of internal timer (Ts) : 0 sec

Multiplexer parameters

Number of inputs : user defined

Circuit Description

The three phase voltage source is connected to the input of the one side of the 3-Φ CB and the other side is connected to the current measurement block, from which we can measure the Inrush or fault current in the phase. The individual circuit breaker output is connected to the primary of the 3Φ power transformer of concern phase. Here multi winding transformer is taken in which divided into three phases of a, b, c. And the transformer has 20 turns in which each of the individual primary and secondary sides of the power transformer for the respective three phases. From these turns winding nominal voltages gets calculated in the transformer. The secondary of the transformer is terminated (open circuited).

Circuit Operation for Inrush current

The three phase circuit breaker is initially opened by opening the switching of phases a, b and c at the instants so that Inrush current flows through the transformer. Initially take the three phase voltage source with ph to ph RMS voltage of 11 KV. Now circuit breaker is placed to that voltage source to identify the transition time or inrush currents. Now one part of the circuit breaker is connected to current measurement

through which we can identify the inrush currents and the other side is connected is connected to the three phase power transformer which is in Y-Y connection. The power transformer is taken in three phases in which individual inrush currents will occur. This has the turns of 20 on each side. From that calculate winding nominal voltages for primary and secondary. Here take inductance as 4% of the resistance. For getting inrush currents secondary of the transformer should be terminated. Then by keeping configuration parameters, switching or transition times correctly using the data we get the inrush currents for three phases which used to get high currents initially and decay up to the transition time occurs. Here the maximum step size in the configuration parameters is taken as 1/16000 since we take 32 samples in which $n=5$ hence for 50Hz frequency we take 16000 steps in size.

To observe in the wavelets, firstly save the current phase in workspace in which is opened on the window of the MATLAB. The energy source is now connected to the power transformer through CB's. From the current measurement, currents through all the three phases are tapped to MATLAB workspace. The data in the workspace is decomposed to Detail coefficients and Approximation coefficients using the wavelet tool box (`>>help wave menu`). The decomposition is done by applying wavelets of mother wavelet Daubichies wavelet with DB 4 at level 5. The approximation and detail levels are seen in the wave menu and the detailed level inrush is seen at d1 in which initially a small spike occurs and next large spike occurred. The circuit breakers are opened at the switching time of 4/50 and proceeds up to 20/50 in which the switching times are taken the frequency of cycles taken as 25/50 so that, that much frequency of samples occur in the simulation. The same procedure is repeated for the next phases. And we can also check at different phase angles, at different switching times and can also check at different wavelets if we want. To get the coefficients in a correct way we go for wavelet statistics where we get the coefficients. Here detailed level d1 is taken and check the coefficient levels. There we get the cumulative histograms approximate coefficient of level 1 and the mean, mode and standard deviation values in an exact way.... The same procedure is applied for b and c phases.

Fault Analysis Turn to ground Faults

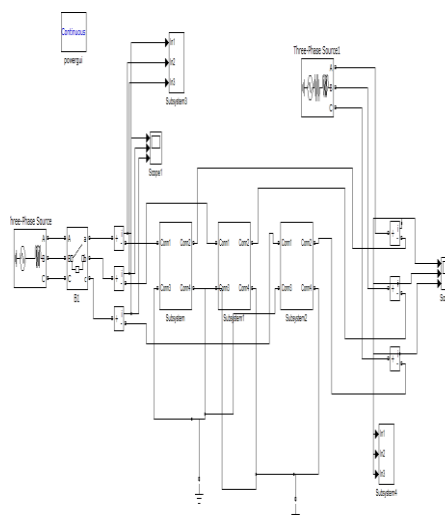

Fig.8 Simulation model for Turn to ground fault

Circuit Description for Turn to ground Faults

The three phase circuit breaker gets closed with high transition time of [30/50 300/50] at the instant rather they are opened so that the breaker gets closed with high transition times when the respective voltage waveforms are taking their maximum value in

order to minimize the inrush effect. Initially the circuit breaker in the main figure gets opened with high transition timings of [1/50 300/50] so that the circuit breaker gets closed position and it gets terminated automatically inside the circuit.

The CB's are closed at their first switching timings as given below. Now circuit breakers are connected to the individual transformers for the respective phases in turn to ground connection. This will be taken on the secondary side of the transformer at the below side i.e. for the phases. The breaker has the switching time of [2/50 50/50]. Here after two cycles the circuit breaker gets opened and gives the fault current with raising current values and trips up to the five cycles since we have given the frequency of 5/50. So the waveform of fault current takes place for five cycles in which the fault current starts after two cycles. Here the step size is taken as 1/250000 steps since we have the sampling frequency of 25 KHZ.

From the current measurement, currents through all the three phases are tapped to MATLAB work space. The data in the workspace is decomposed to Detail coefficients and Approximation coefficients using the wavelet tool box (>>help *wavemenu*). The decomposition is done by using four different mother wavelets viz Daubichies wavelet (db 2), Haar wavelet (haar), Symlet wavelet. And here the decomposition has checked for DB 4 at level 5. The coefficients and the statistics for the coefficients of the approximation levels are also taken so that the peak and standard values of the coefficients will occur and can also check using the wavelet program which is used to be in the given below. The same procedure is applied for b and c phases.

Circuit Description for Turn to Turn Faults

Here the procedure is same as the turn to turn fault but there is a slight change in the connection of the circuit breaker in the individual transformer. In the turn to ground the breaker is kept at the below level of the one turn of the transformer. By connecting the one side of the breaker to the individual transformer turn at different switching times and the other side of the breaker to the other turn of the transformer we get turn to turn fault at the switching angle of [4/50 50/50]. The cycles per second is taken as 8/50. Hence it takes 8 cycles for each phase. Then the wavelets procedure is the same as the above fault.

Circuit Description for faults with inrush currents

This is the combination of fault currents and inrush currents. And here turn to ground fault is taken at phase of the transformer and no faults are taken at other phases for occurrence of inrush currents. Initially the circuit breaker gets opened at the main circuit of the breaker. The breaker should be closed in the transformer where the fault is taken. Here we take different switching times at different phase angles in the individual phases of the transformer. The cycles/second is taken as 25/50. Hence 25 samples can be seen in the simulation. The phase angles taken are 90, 60, 45 for phases a, b, c. So that we get that fault with inrush in between these switching times. The switching times taken are [0.25/50 300/50], [0.16/50 300/50], [0.125/50 300/50]. The secondary connection of the three phase voltage source gets terminated since for getting inrush. Hence fault for phase A is seen and inrush current occurs for the other two phases. Hence called fault with inrush currents. The wavelets procedure is same as the above.

Algorithm for the procedure

- Take minimum as threshold value. Here the value is given as 0.4

- Calculate wavelet coefficients absolute values as per the program shown below.
- Extracting the d1 coefficients from original current signals.
- The absolute peak values of d1 coefficients for all the three phases set as a fault indices.
- Fault indication is based on fault indices which are greater than the predefined threshold, otherwise there is no fault.
- Fixing the threshold value by considering the minimum value under all fault cases and maximum value under healthy case.

Simulation results

Because of the facility to allow the use of variable window length, WT is useful in analyzing transient phenomena such as those associated with line faults and/or switching operations. Unlike FT, wavelet analysis has the ability to analyze a localized area of a signal and can reveal aspects of data like break points, discontinuities, etc. WT is thus useful in detecting onset of a fault and in realizing non stationary signals comprising both low and high frequency components. Wavelet transform gives an adequate emphasis to depict the real-time implementation of fault detection and classification algorithm. Wavelets are mathematical tools for signal analysis. Wavelet analysis is particularly efficient where the signal being analyzed has transients or discontinuities, e.g., the post-fault voltage/current waveform.

Simulation results for inrush currents

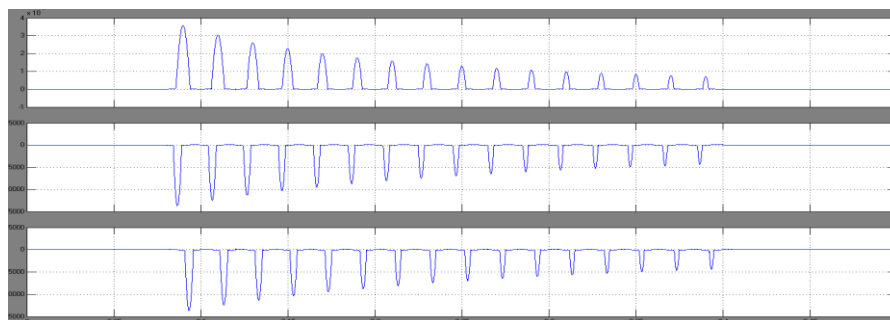

Fig.9 Simulation results for the magnetising inrush currents

The above gives the simulation results for inrush currents. There initially high starting currents occurred and simultaneously these go to decay. From fig 7.2 the 5 level coefficient waveforms are got along with signal and approximation signal. The inrush is seen clearly in d1 level from the waveforms. From fig 7.3 the inrush signal with d1 level coefficient is seen. The inrush got is in between 0.08 to 0.4 since we have given the switching time is in between 4/50 and 20/50. The peak value getting from the program is 55.4324.

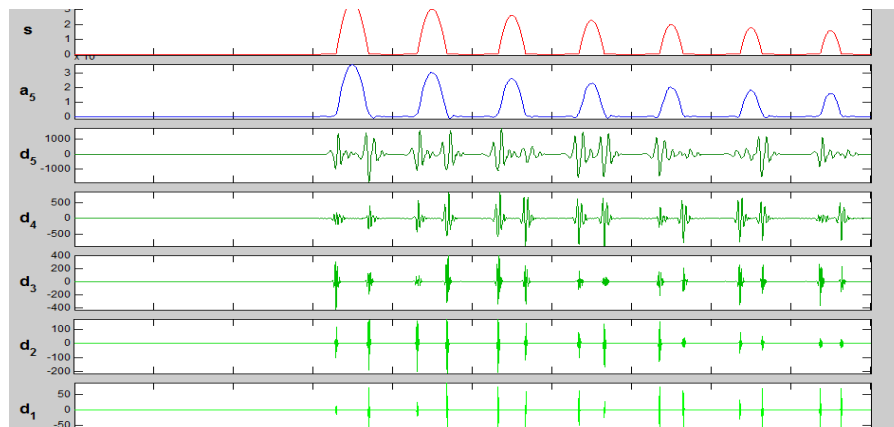

Fig 10 d level coefficients from the wavemenu for phase A

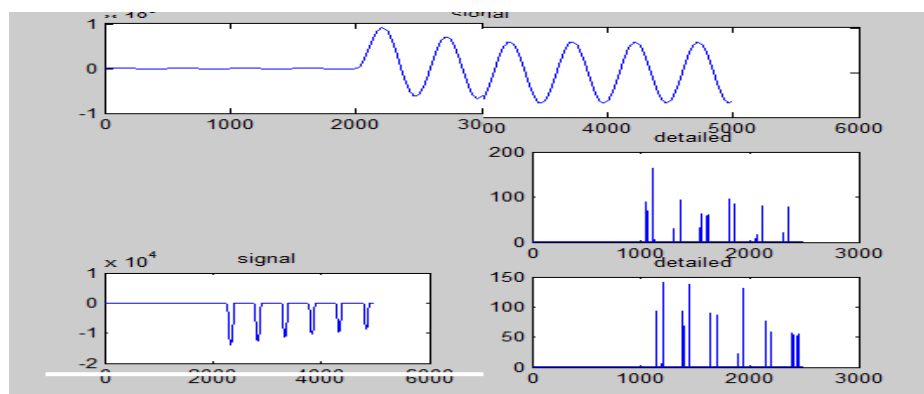

Fig 11 graphs for the program

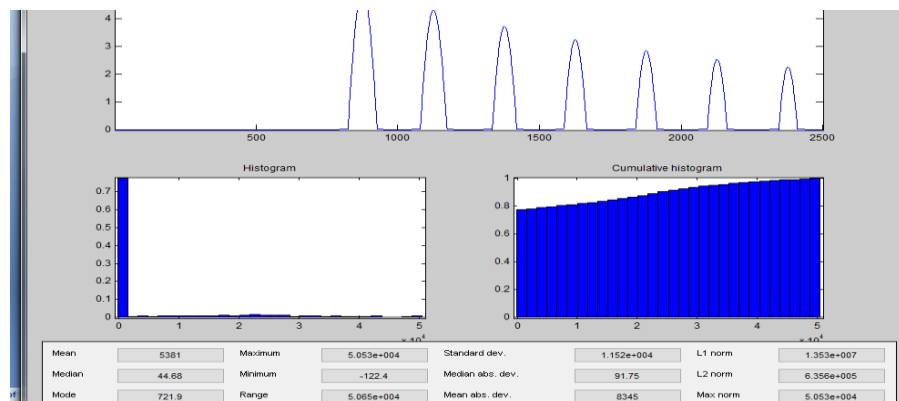

Fig 12 wavelet statistics for inrush currents

From the above statistics, it can be said that the inrush waveform and its cumulative histogram has seen clearly and also the values of mean median mode and the standard deviation values also got in a clear way by taking statistics in the wavemenu after we got the d- level coefficients. From there by clicking coefficients at detail level 1 we get the values for the d1 level where we get the inrush currents in a clear way. The same is done for phases b and c.

Simulation results for Turn to ground faults

The peak values getting are 95.2367 for phase a, 221.1666 for phase b, 243.3452 for phase c as per the program written below.

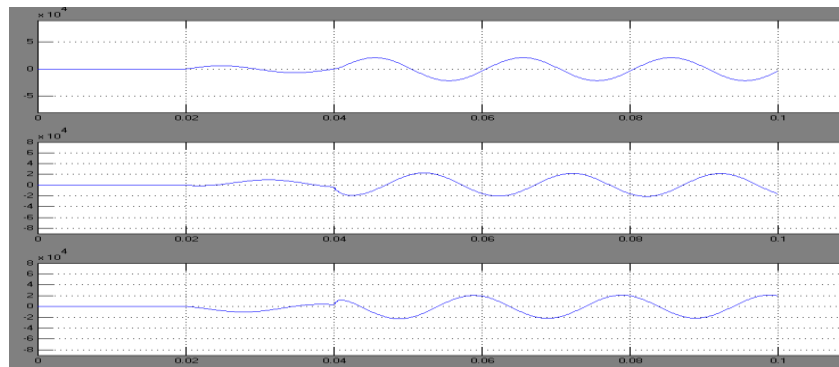

Fig 13 simulation graph for turn to ground fault

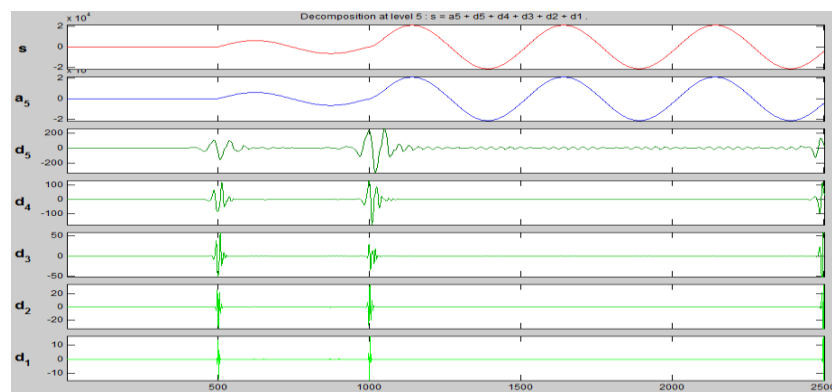

Fig 14 graphs from the wavemenu in the wavelets

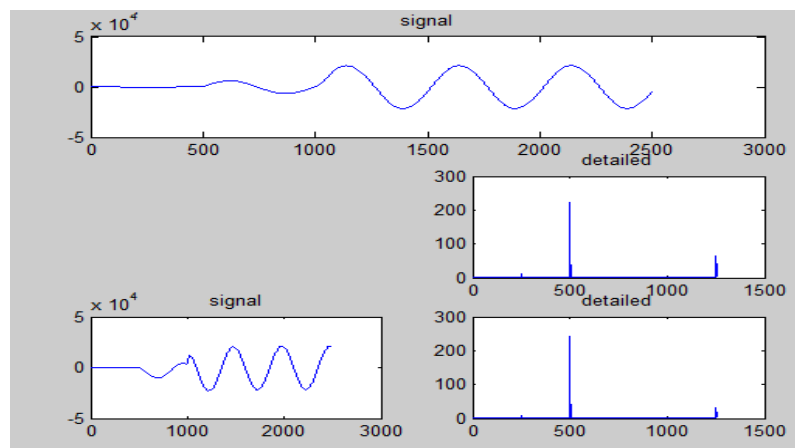

Fig 15 Graphs for the Program.

Simulation results for turn to turn fault

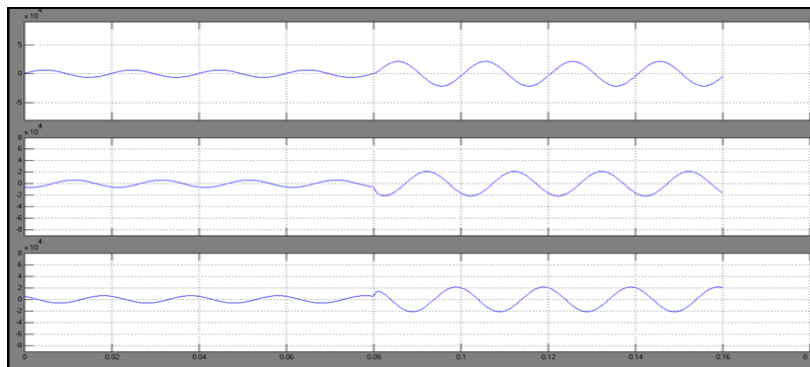

Fig 16 simulation graph for turn to turn fault

The peak values getting are 95.2401 for phase A, 165.2499 for phase B, 181.4838 for phase C from the program written below

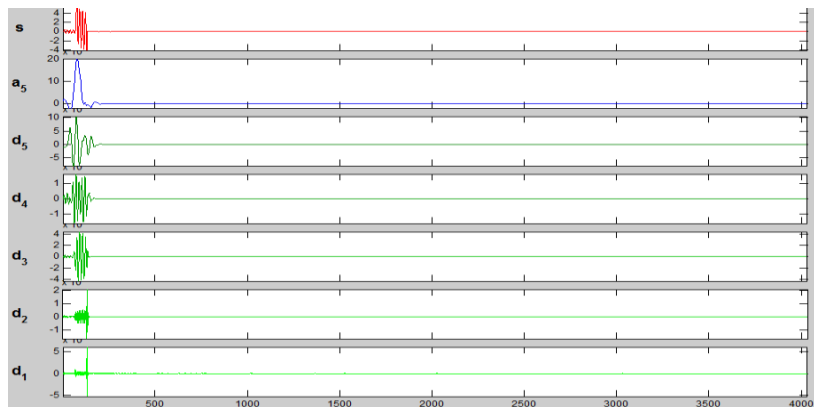

Fig 17 graphs from the wavemenu in the wavelets

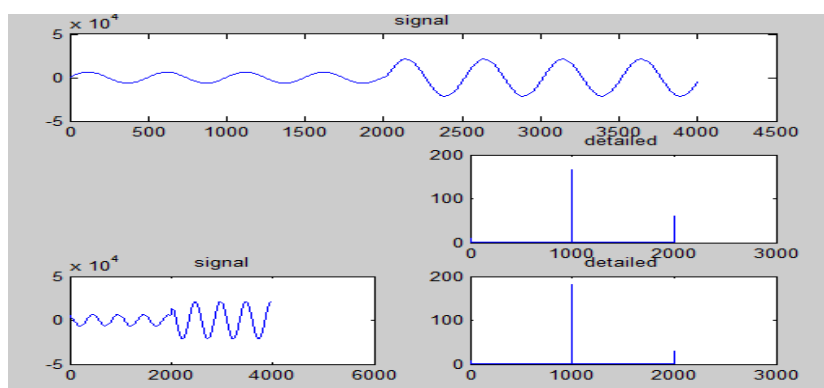

Fig 18 Graphs from the program simulation results for faults with inrush currents

The peak values getting are 110.6488 for phase A, 162.8894 for phase B, 141.1283 for phase c from the program written below.

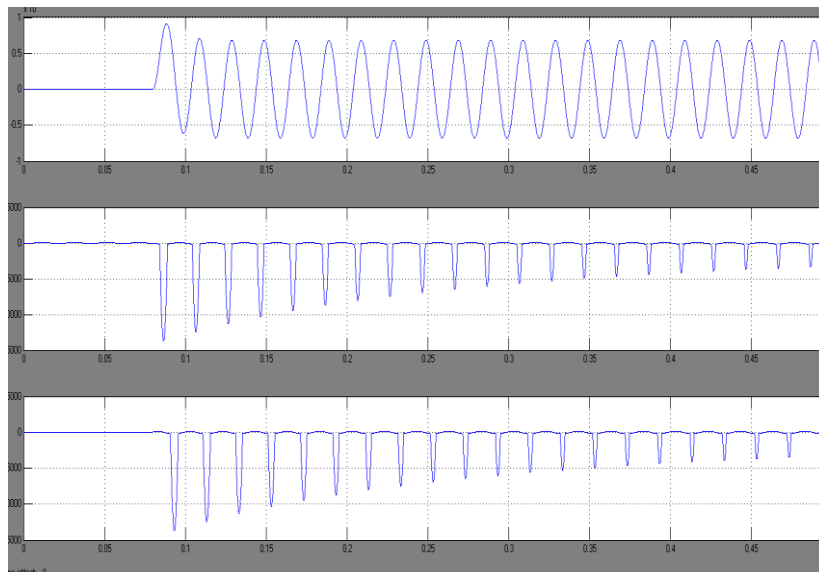

Fig 19 simulation graph for fault with inrush current

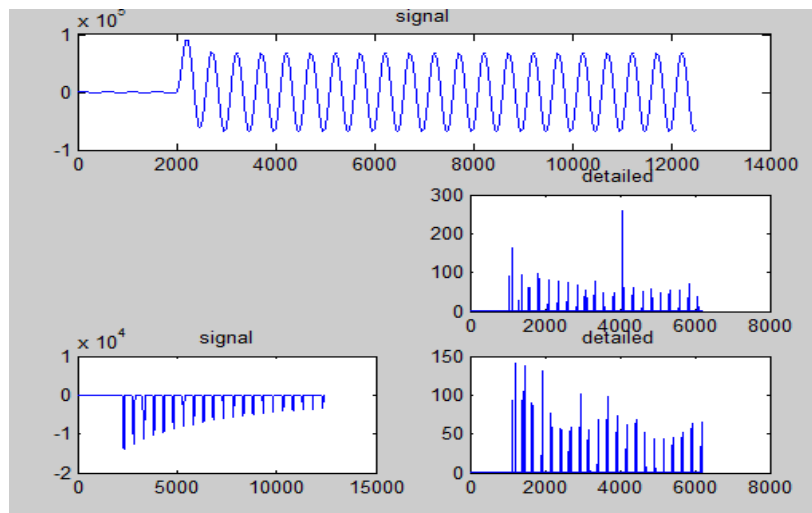

Fig 20 graphs for program

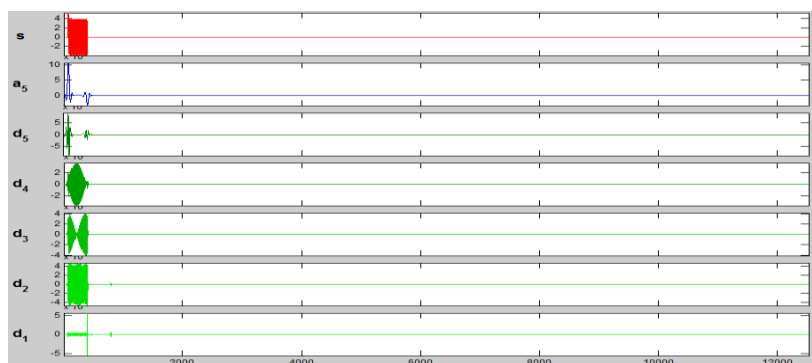

Fig 21 graphs from the wave menu of wavelets

Conclusions

Extensive simulation studies have shown that the wavelet transforms of magnetising inrush currents and internal fault currents have the following different features. For internal fault cases shown in Figs above, we can clearly see that there are several sharp spikes appearing from the inception time of the internal fault. The maximum value of the sharp spike appears at the beginning of the fault. However, in marked contrast to the inrush current cases shown in Figs. above of faults, these sharp spikes rapidly decay to near zero within one cycle. Whereas those sharp spikes under inrush current cases suffer from little attenuation during the entire inrush transient period, which can last from perhaps 10 cycles for small transformers to 1 min for large units. It is apparent that this difference can be used as the key feature to effectively distinguish internal faults from inrush currents.

References

1. Rah man MA, Jeyasurya B. A state-of-the-art review of transformer protection algorithms. *IEEE Trans Power Delivery* 1988; 3(2):534 – 44.
2. Horowitz SH, Phadke AG. *Power system relaying*. 2nd ed.. Somerset, UK: Research Studies Press Ltd, 1995.
3. Elmore WA. *Protective relaying theory and applications*. Coral Springs, FL: ABB Power T&D Company Inc, Relay Division, 1994.
4. Liu P, Malik OP, Chen D, Hope GS, Guo Y. Improved operation of the differential protection of power transformers for internal faults. *IEE Trans Power Delivery* 1992; 7(4):1912–9.
5. Sidhu TS, Sachdev MS, Wood HC, Nag pal M. Design, implementation and testing of a microprocessor-based high-speed relay for detecting transformer winding faults. *IEEE Trans Power Delivery* 1992; 7(1):108–17.
6. Perez LG, Flechsig AJ, Meador JL, Obradovic Z. Training an artificial neural network to discriminate between magnetizing inrush and internal fault. *IEEE Trans Power Delivery* 1994; 9(1):434–41.
7. Bastard P, Meunier M, Regal H. Neural network-based algorithm for power transformer differential relays. *IEE Proc, Generation, Transmission Distribution* 1995; 142(4):386–92.
8. Pihler J, Grcar B, Dolinar D. Improved operation of power transformer protection using artificial neural network. *IEEE Trans Power Delivery* 1997; 12(3):1128–36.
9. Kasztenny B, Lukowicz M, Rosolowski E. Selecting type of a neural network, pre- and post-processing algorithms for power transformer relaying. 32nd University Power Engineering Conference, September, 1997. p. 708–12.
10. Zaman MR, Rah man MA. Experimental testing of the artificial neural network based protection of power transformers. *IEEE Trans Power Delivery* 1998; 13(2):510–7.
11. Wiszniewski A, Kasztenny B. A multi-criteria differential transformer relay based on fuzzy logic. *IEEE Trans Power Delivery* 1995; 10(4):1786–92.
12. Kasztenny B, Rosolowski E, Saha MM, Hillstrom B. A self-organizing fuzzy logic based protective relay-an application to power transformer protection. *IEEE Trans Power Delivery* 1997; 12(3):1119–27.
13. Kezunovic M, Fro men CW, Phillips F. Experimental evaluation of EMTP-based current transformer models for protective relay transient study. *IEEE Trans Power Delivery* 1994; 9(1):405–13.